

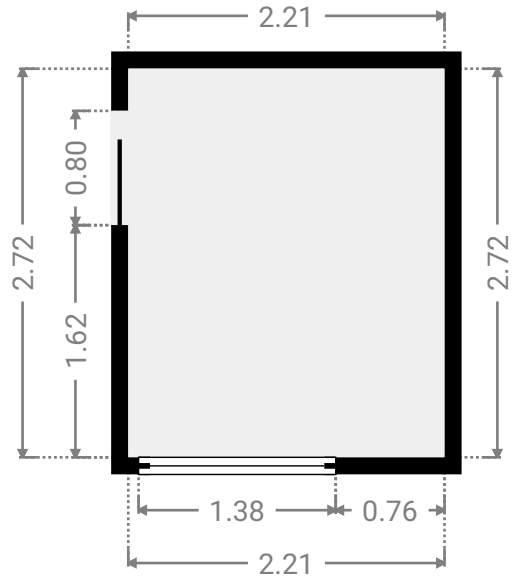

▼ Akupunktur
Erdgeschoss

BREITE: 2.21 m • LÄNGE: 2.72 m
BEREICH: 6.02 m² • UMFANG: 9.87 m

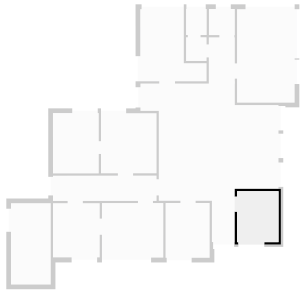

▼ Behandlungsraum
Erdgeschoss

BREITE: 2.21 m • LÄNGE: 4.46 m
BEREICH: 9.86 m² • UMFANG: 13.34 m

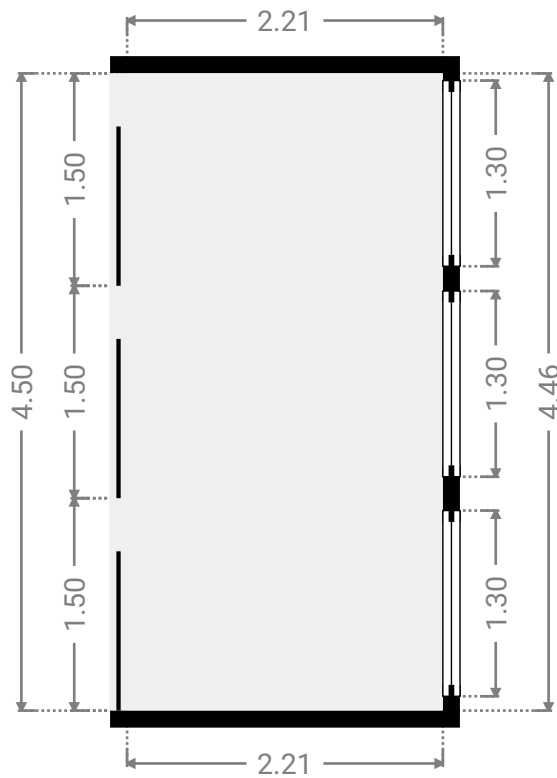
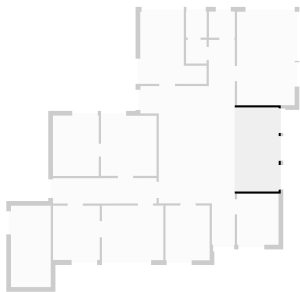

▼ **Diele**
Erdgeschoss

BREITE: 5.52 m • LÄNGE: 1.35 m
BEREICH: 7.44 m² • UMFANG: 13.73 m

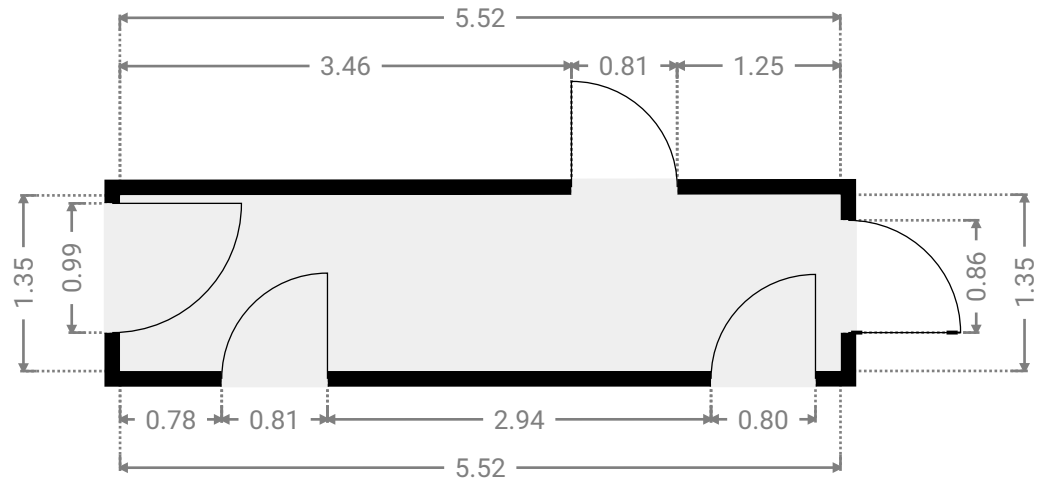
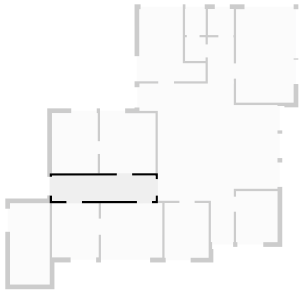

▼ **EKG**
Erdgeschoss

BREITE: 2.35 m • LÄNGE: 2.92 m
BEREICH: 6.86 m² • UMFANG: 10.54 m

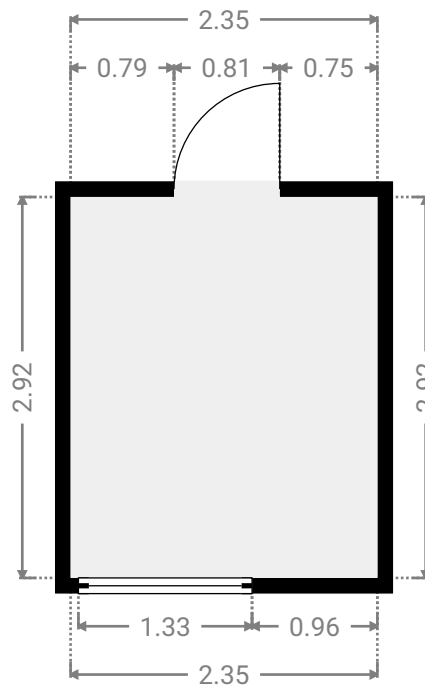
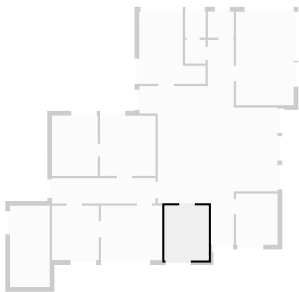

▼ Eingang
Erdgeschoss

BREITE: 1.38 m • LÄNGE: 1.39 m
BEREICH: 1.92 m² • UMFANG: 5.54 m

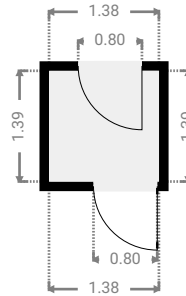
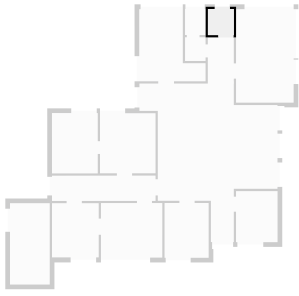

▼ Empfang
Erdgeschoss

BREITE: 5.03 m • LÄNGE: 8.45 m
BEREICH: 29.40 m² • UMFANG: 26.95 m

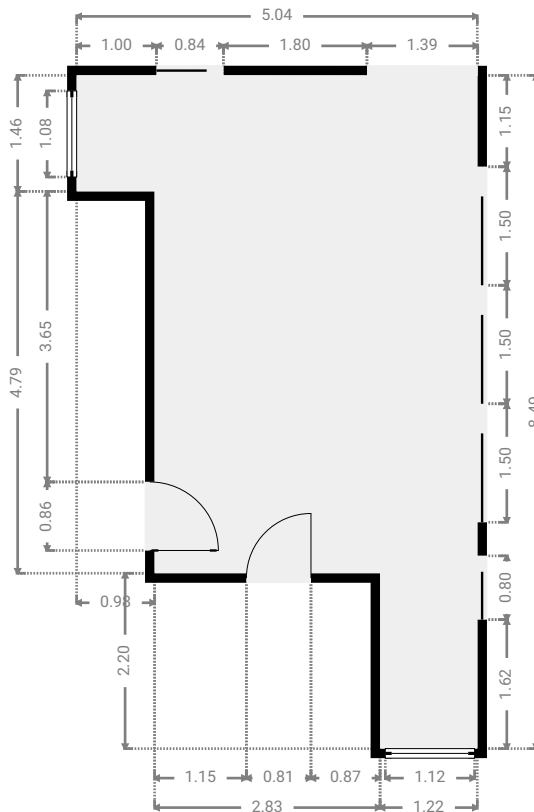
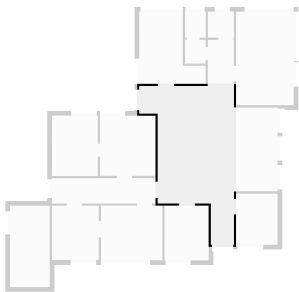

▼ **Flur**
Erdgeschoss

BREITE: 1.39 m • LÄNGE: 2.34 m
BEREICH: 3.25 m² • UMFANG: 7.46 m

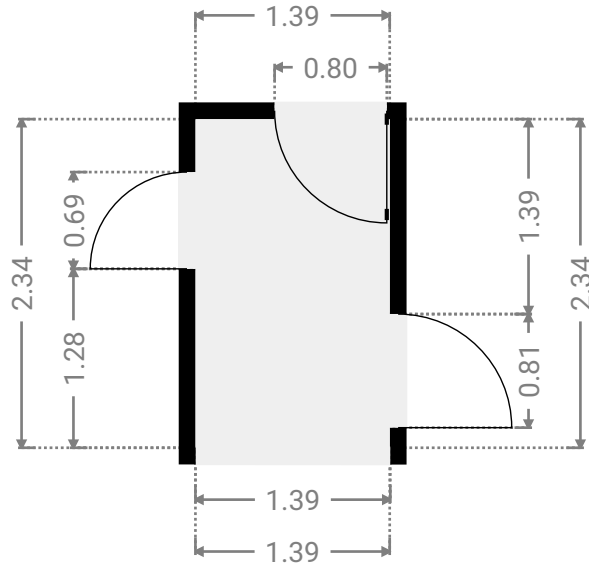
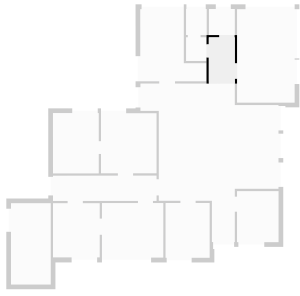

▼ **Küche**
Erdgeschoss

BREITE: 3.53 m • LÄNGE: 3.85 m
BEREICH: 10.09 m² • UMFANG: 14.75 m

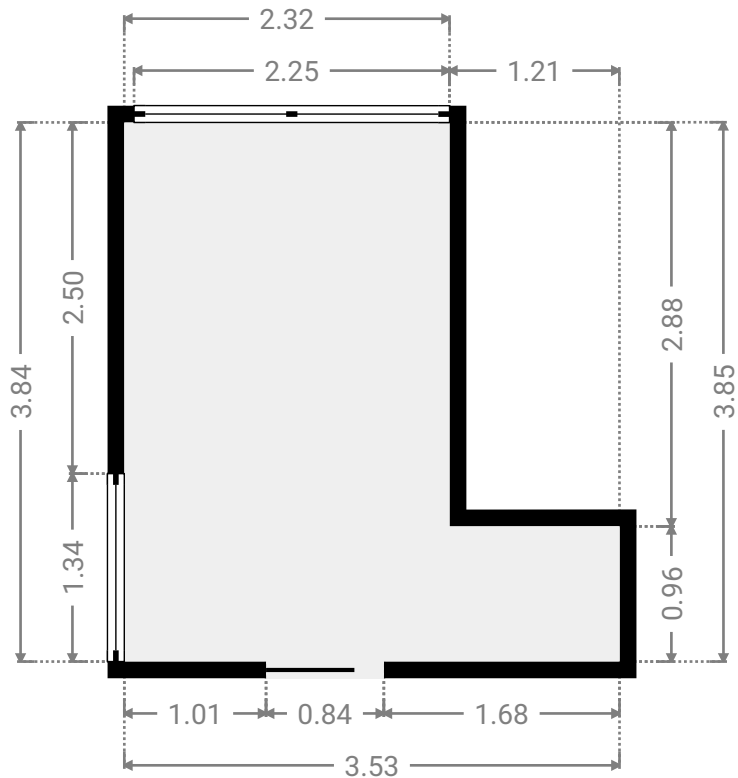
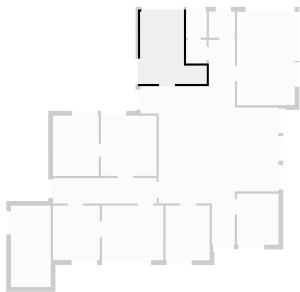

▼ **Sprechzimmer**
Erdgeschoss

BREITE: 3.27 m • LÄNGE: 2.91 m
BEREICH: 9.50 m² • UMFANG: 12.35 m

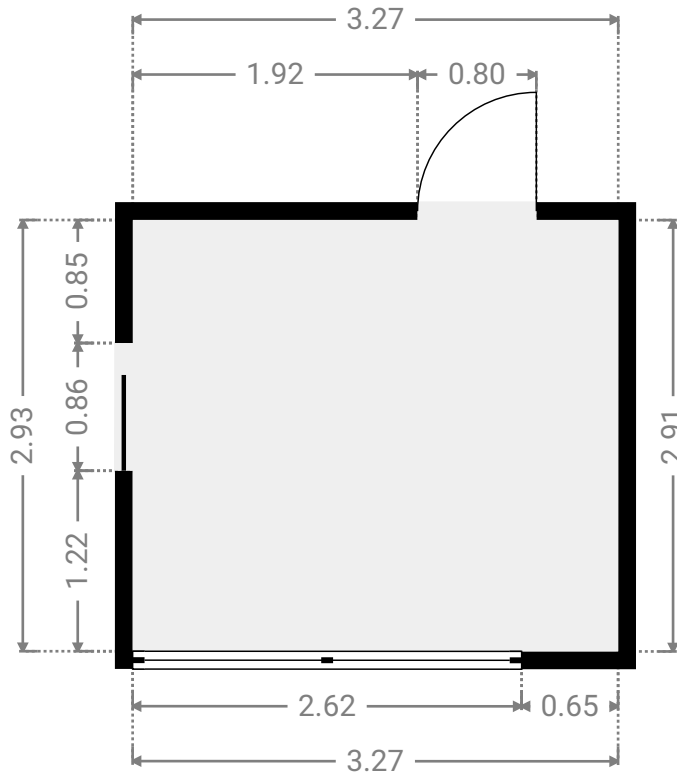
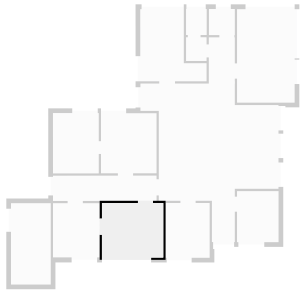

▼ **Sprechzimmer 2**
Erdgeschoss

BREITE: 2.96 m • LÄNGE: 3.20 m
BEREICH: 9.47 m² • UMFANG: 12.32 m

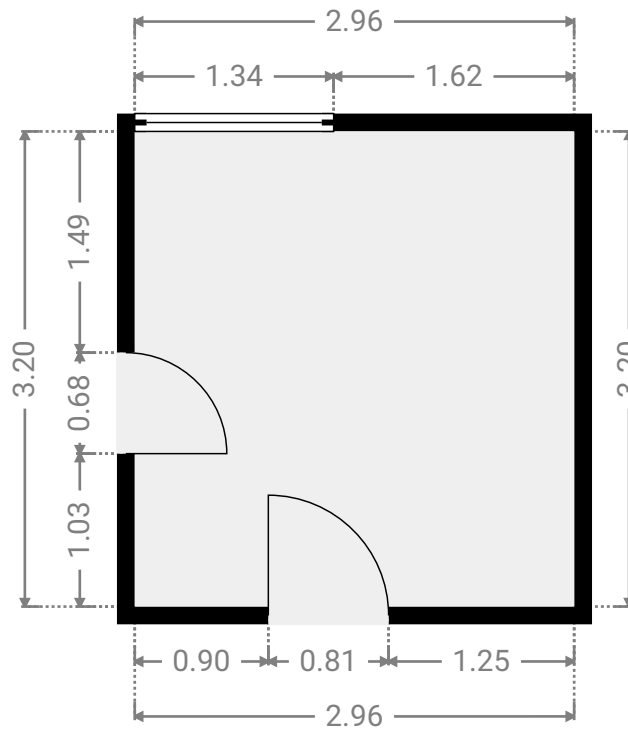
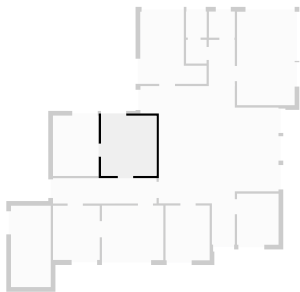

▼ **Treppenhaus**
Erdgeschoss

BREITE: 2.12 m • LÄNGE: 4.33 m
BEREICH: 9.18 m² • UMFANG: 12.90 m

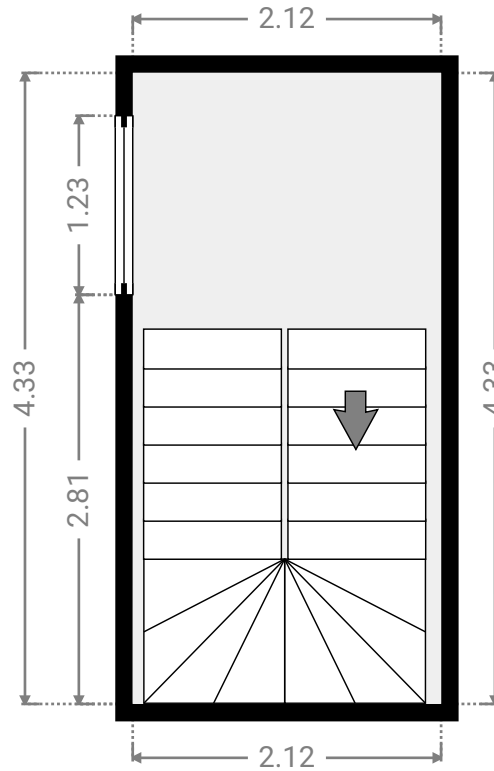
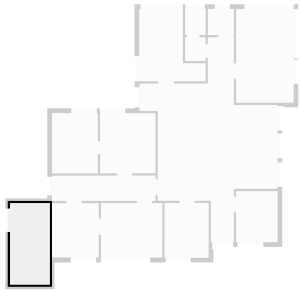

▼ **Ultraschall**
Erdgeschoss

BREITE: 2.49 m • LÄNGE: 2.89 m
BEREICH: 7.19 m² • UMFANG: 10.75 m

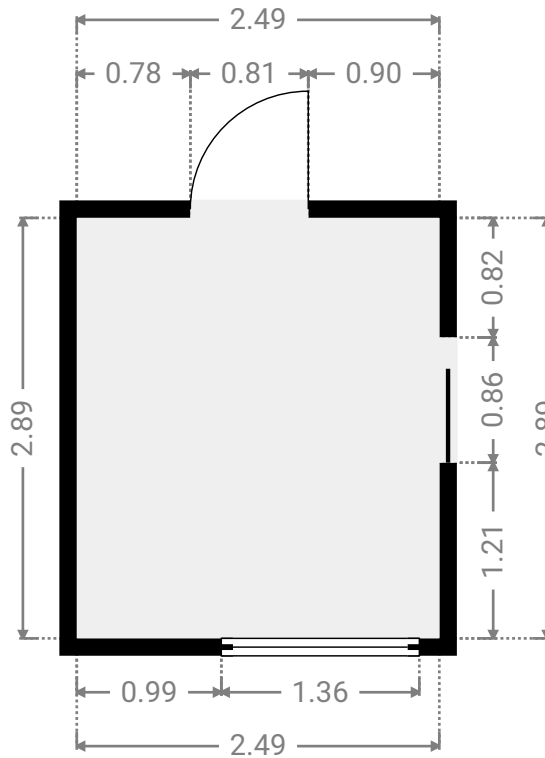
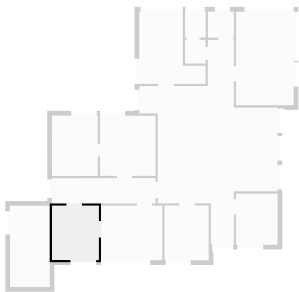

▼ **Umkleide**
Erdgeschoss

BREITE: 2.44 m • LÄNGE: 3.22 m
BEREICH: 7.85 m² • UMFANG: 11.31 m

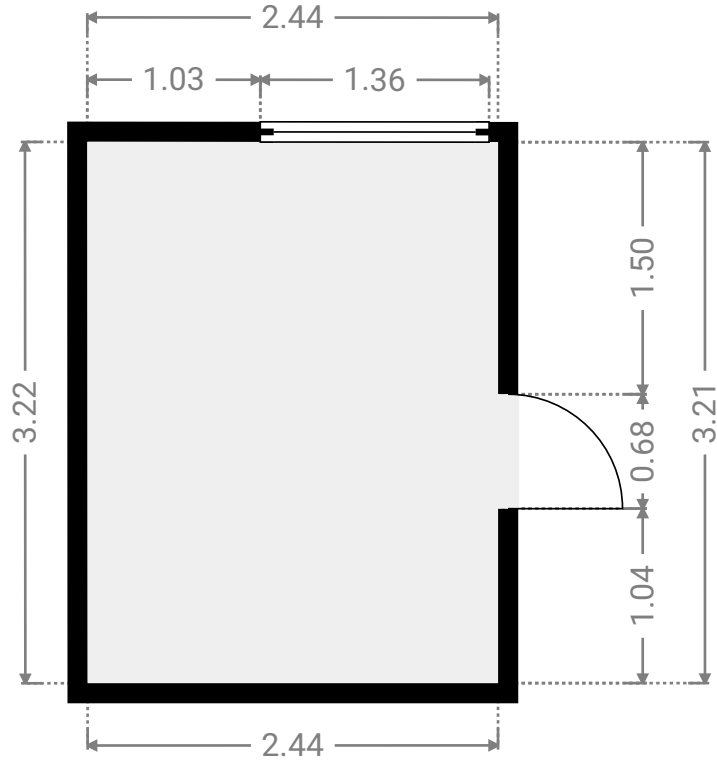
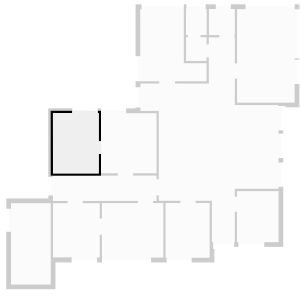

▼ **WC**
Erdgeschoss

BREITE: 1.10 m • LÄNGE: 1.39 m
BEREICH: 1.52 m² • UMFANG: 4.97 m

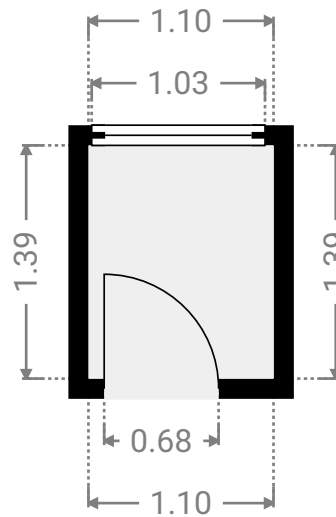
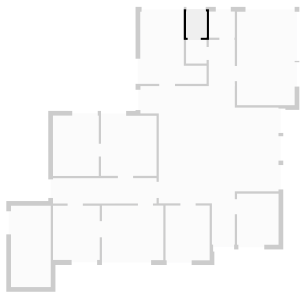

▼ WC
Erdgeschoss

BREITE: 1.09 m • LÄNGE: 1.26 m
BEREICH: 1.38 m² • UMFANG: 4.71 m

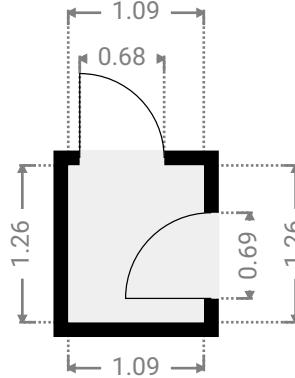
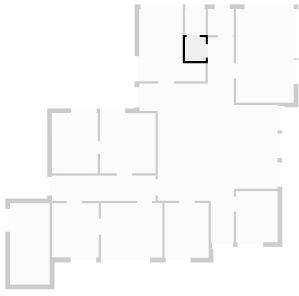

▼ Wartezimmer
Erdgeschoss

BREITE: 3.07 m • LÄNGE: 4.98 m
BEREICH: 15.29 m² • UMFANG: 16.10 m

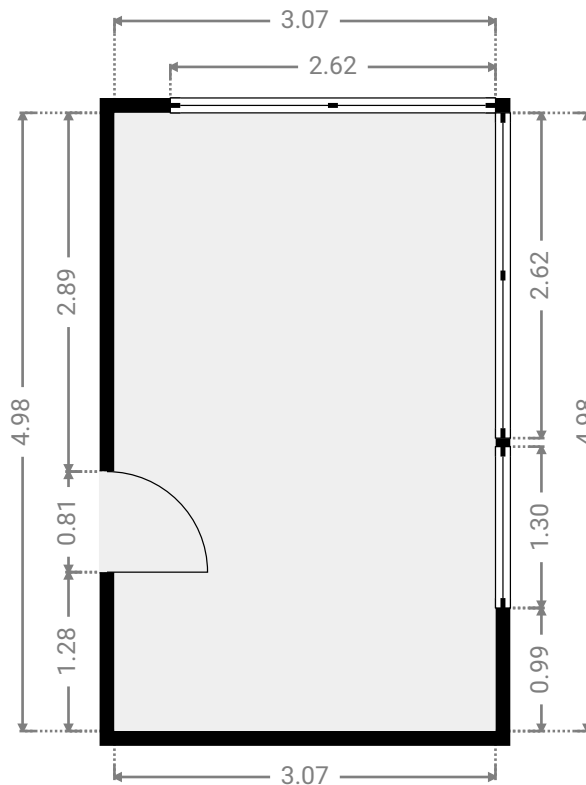
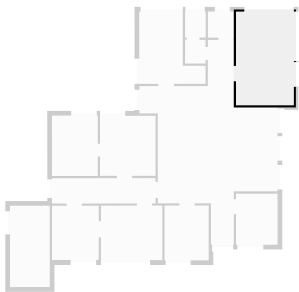

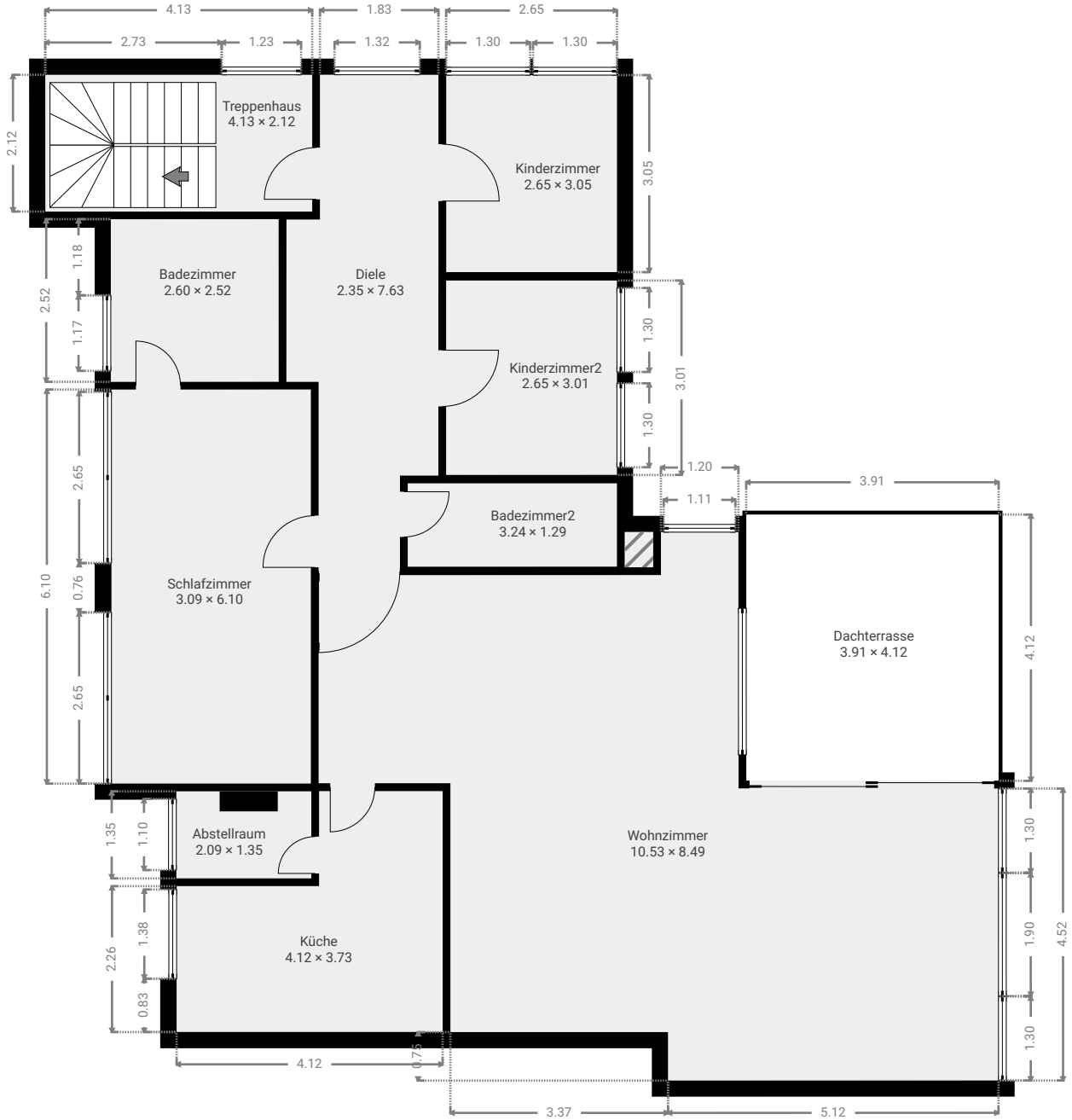

▼ **Badezimmer**
1. Stock

BREITE: 2.52 m • LÄNGE: 2.60 m
BEREICH: 6.55 m² • UMFANG: 10.24 m

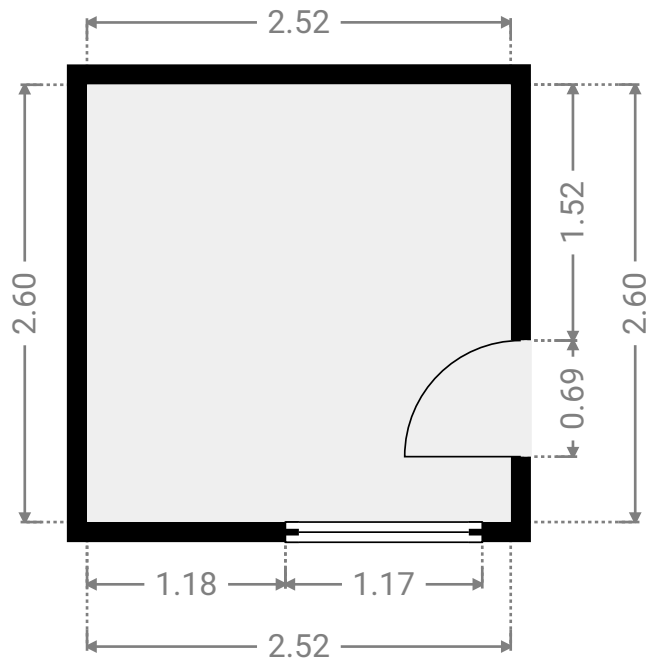
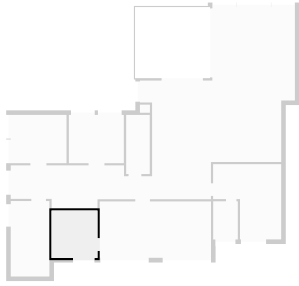

▼ **Badezimmer2**
1. Stock

BREITE: 1.29 m • LÄNGE: 3.24 m
BEREICH: 4.18 m² • UMFANG: 9.06 m

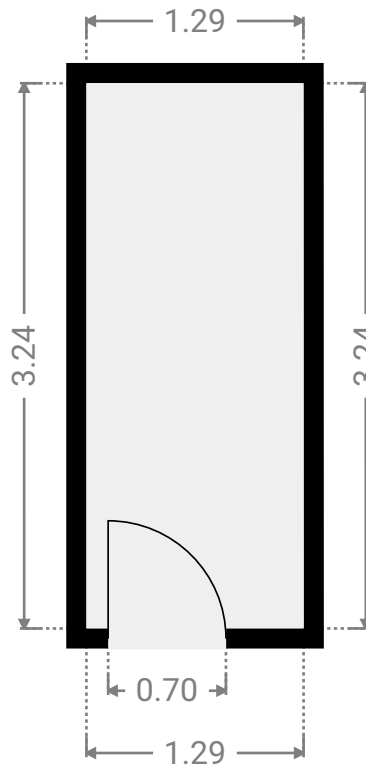
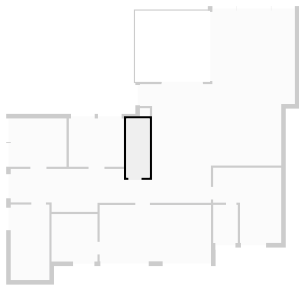

▼ **Diele**
1. Stock

BREITE: 7.63 m • LÄNGE: 2.35 m
BEREICH: 14.51 m² • UMFANG: 19.96 m

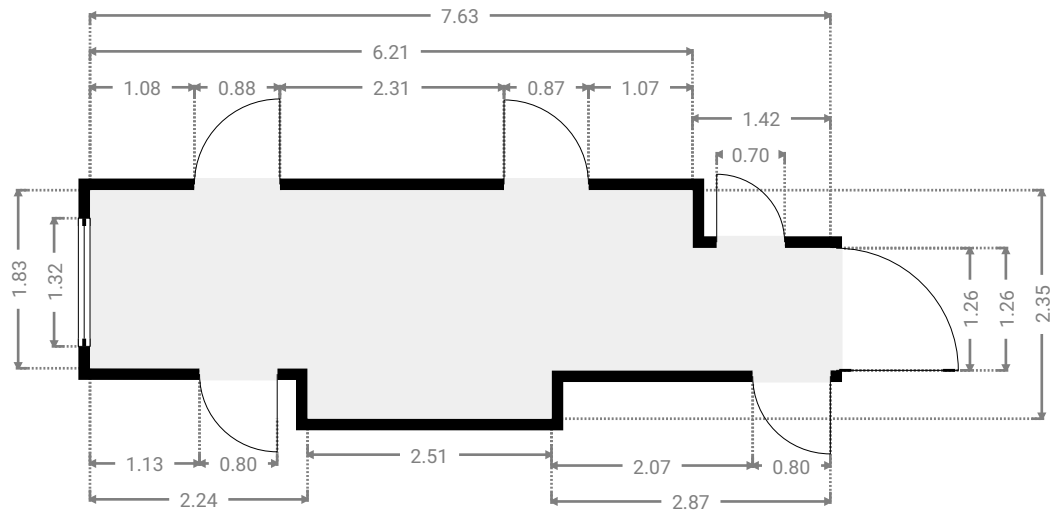
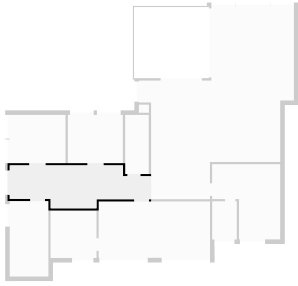

▼ **Kinderzimmer**
1. Stock

BREITE: 3.05 m • LÄNGE: 2.65 m
BEREICH: 8.07 m² • UMFANG: 11.39 m

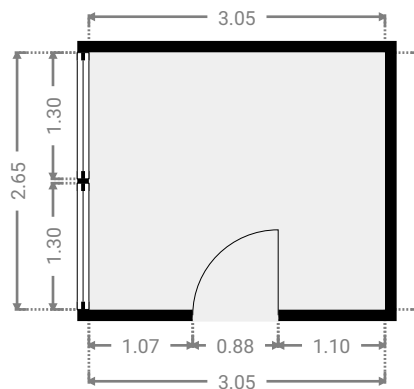
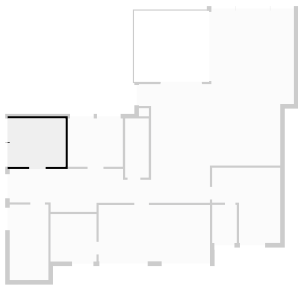

▼ **Kinderzimmer2**
1. Stock

BREITE: 3.01 m • LÄNGE: 2.65 m
BEREICH: 7.96 m² • UMFANG: 11.31 m

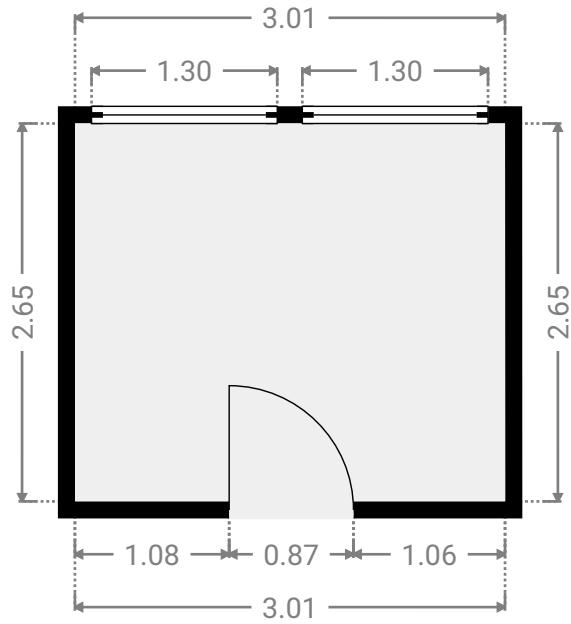
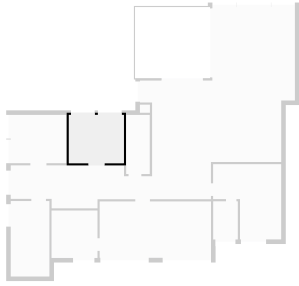

▼ **Küche**
1. Stock

BREITE: 3.73 m • LÄNGE: 4.12 m
BEREICH: 12.12 m² • UMFANG: 15.70 m

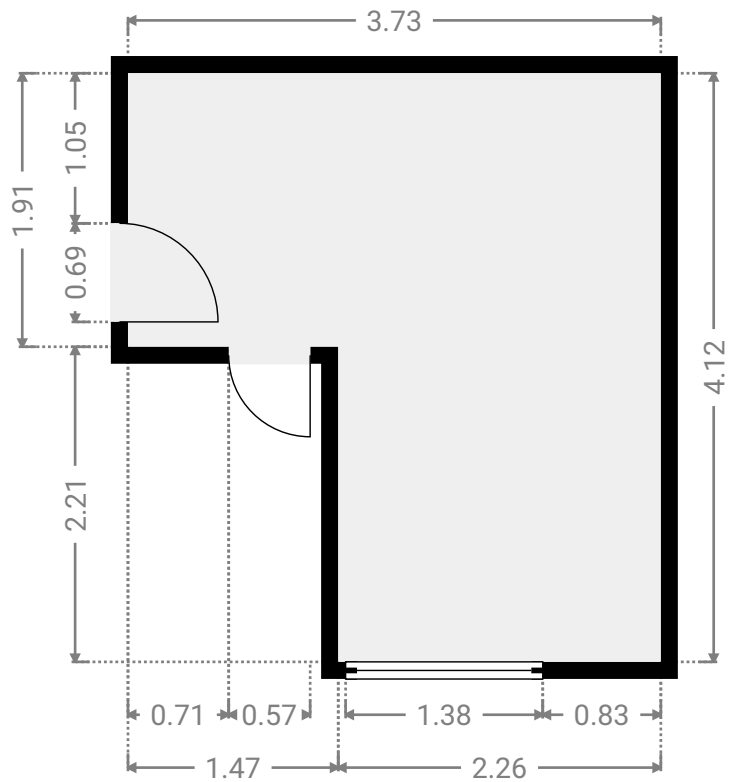
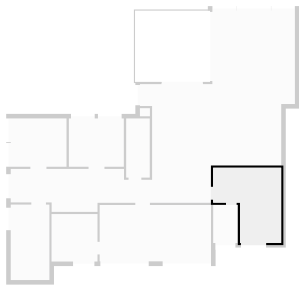

▼ **Abstellraum**
1. Stock

BREITE: 1.35 m · LÄNGE: 2.09 m
BEREICH: 2.82 m² · UMFANG: 6.88 m

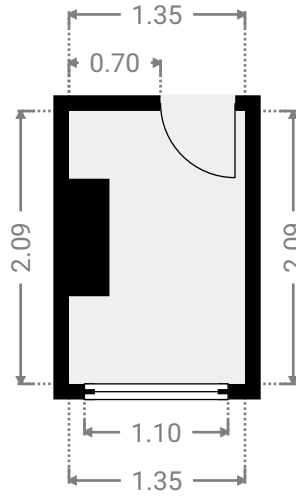
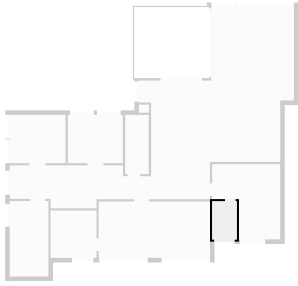

▼ **Schlafzimmer**
1. Stock

BREITE: 6.10 m · LÄNGE: 3.09 m
BEREICH: 18.83 m² · UMFANG: 18.38 m

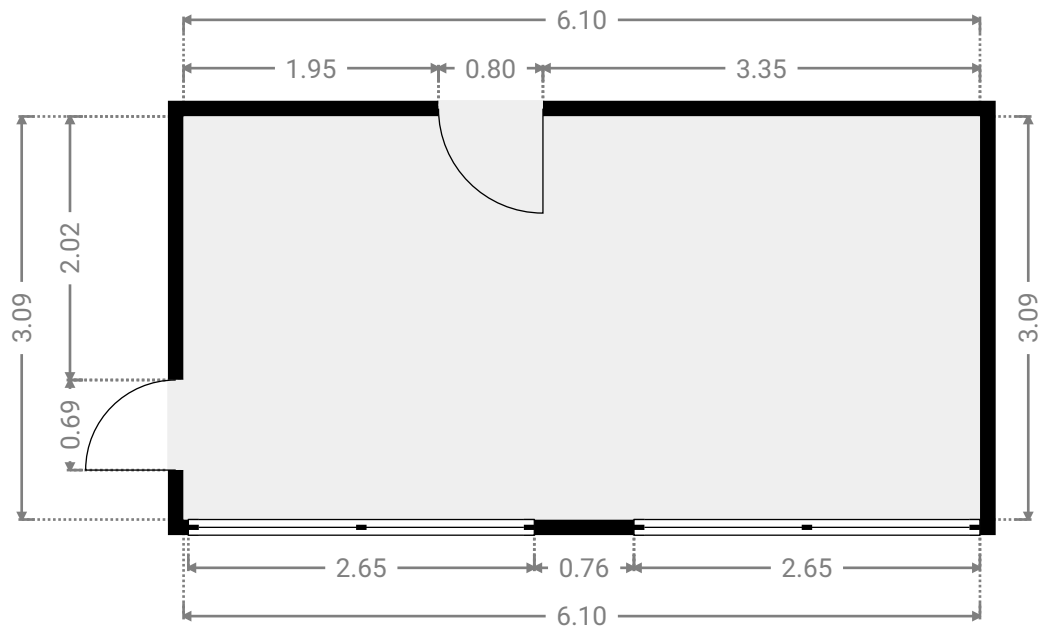
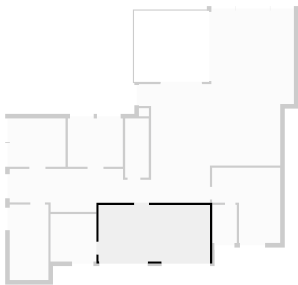

▼ **Treppenhaus**
1. Stock

BREITE: 2.12 m · LÄNGE: 4.13 m
BEREICH: 8.75 m² · UMFANG: 12.50 m

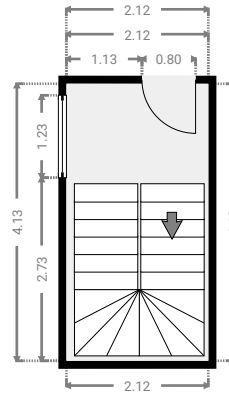
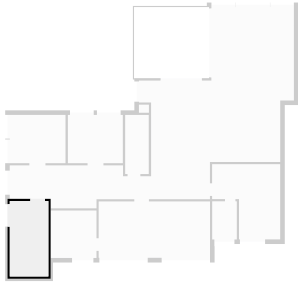

▼ **Wohnzimmer**
1. Stock

BREITE: 8.49 m · LÄNGE: 10.53 m
BEREICH: 57.97 m² · UMFANG: 38.03 m

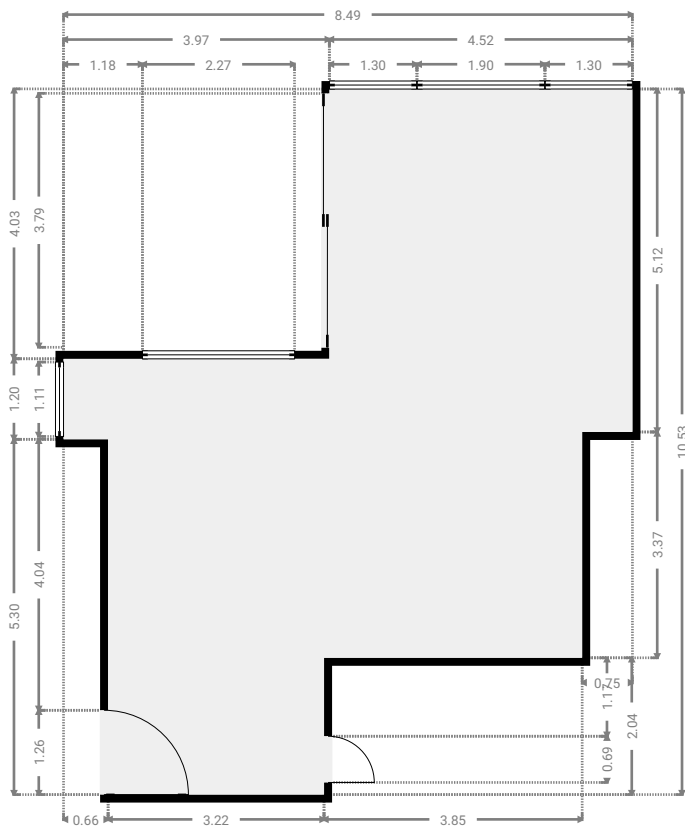
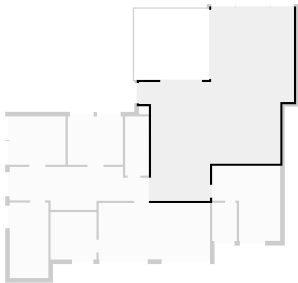

▼ **Dachterrasse**
1. Stock

BREITE: 4.12 m • LÄNGE: 3.91 m
BEREICH: 16.12 m² • UMFANG: 16.06 m

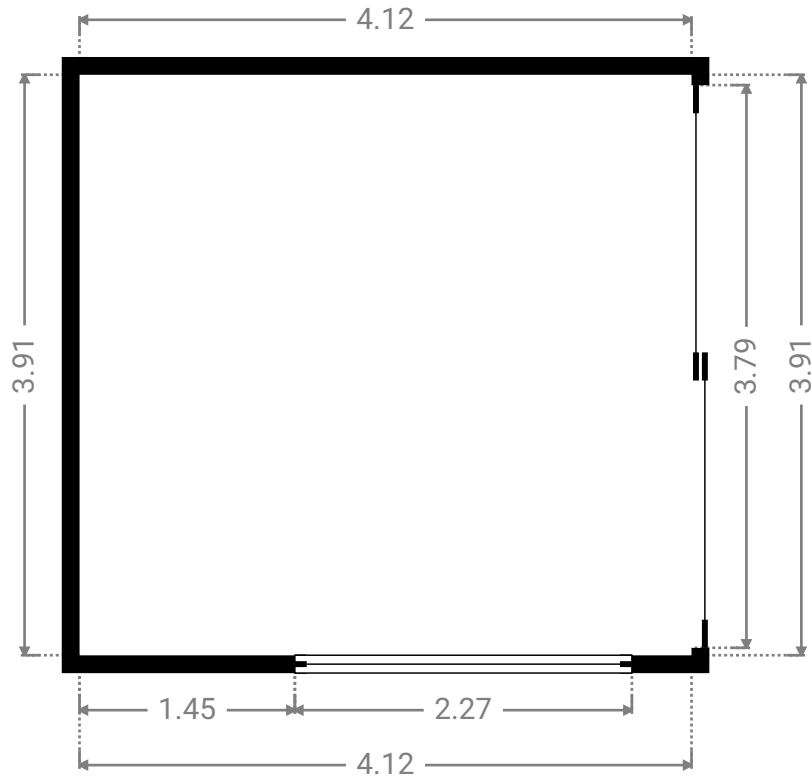
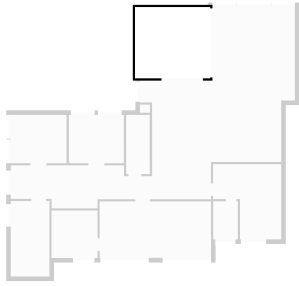

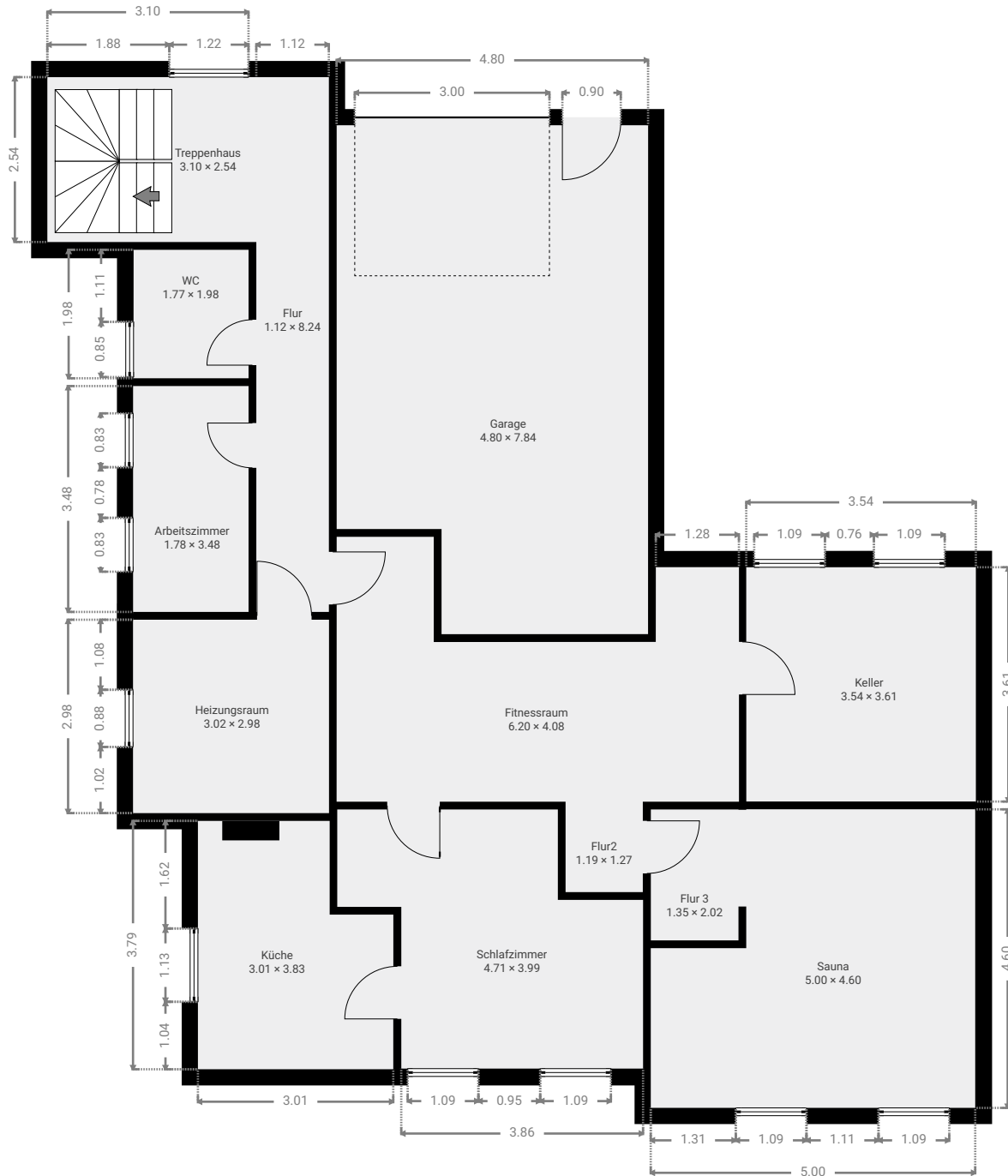

▼ **Arbeitszimmer**
1. Untergeschoss

BREITE: 3.48 m • LÄNGE: 1.78 m
BEREICH: 6.19 m² • UMFANG: 10.52 m

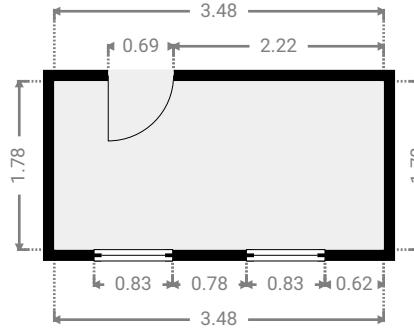
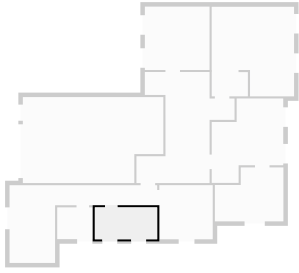

▼ **Fitnessraum**
1. Untergeschoss

BREITE: 4.08 m • LÄNGE: 6.20 m
BEREICH: 19.16 m² • UMFANG: 22.86 m

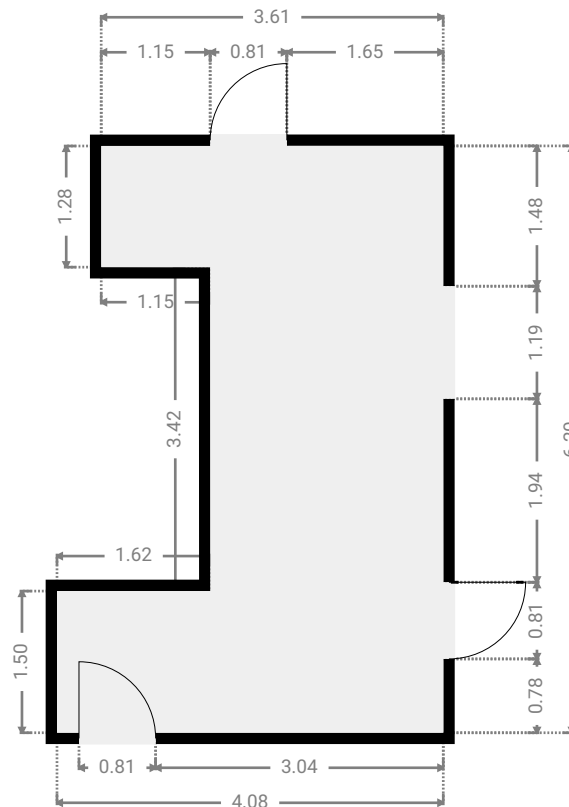
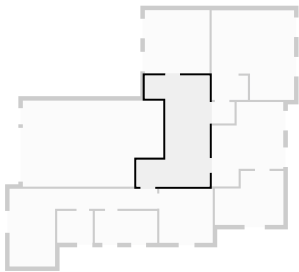

▼ **Flur**
1. Untergeschoss

BREITE: 8.24 m • LÄNGE: 1.12 m
BEREICH: 9.21 m² • UMFANG: 18.72 m

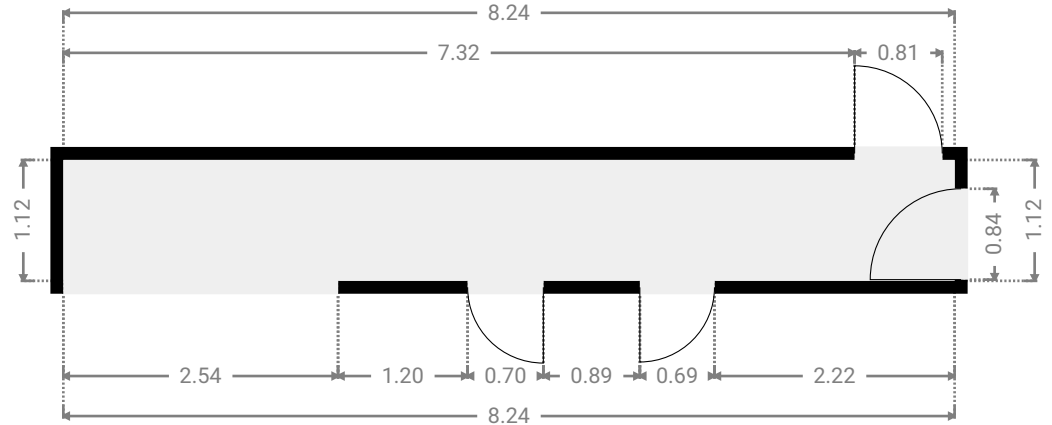
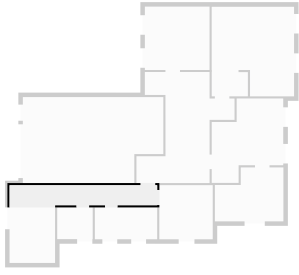

▼ **Flur 3**
1. Untergeschoss

BREITE: 2.02 m • LÄNGE: 1.35 m
BEREICH: 2.72 m² • UMFANG: 6.73 m

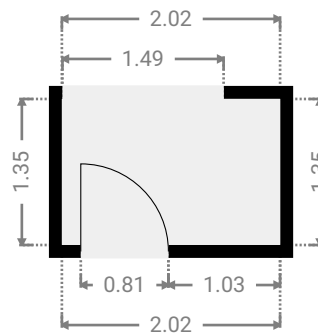
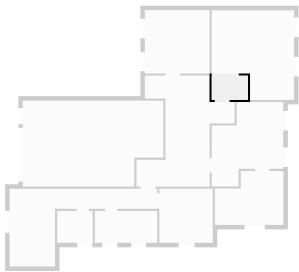

▼ **Flur2**
1. Untergeschoss

BREITE: 1.27 m · LÄNGE: 1.19 m
BEREICH: 1.51 m² · UMFANG: 4.92 m

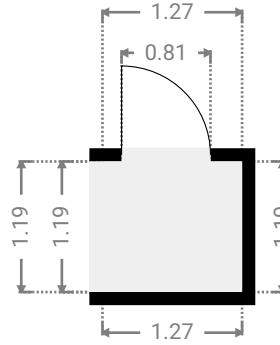
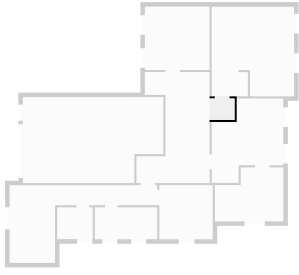

▼ **Garage**
1. Untergeschoss

BREITE: 7.84 m · LÄNGE: 4.80 m
BEREICH: 35.01 m² · UMFANG: 25.28 m

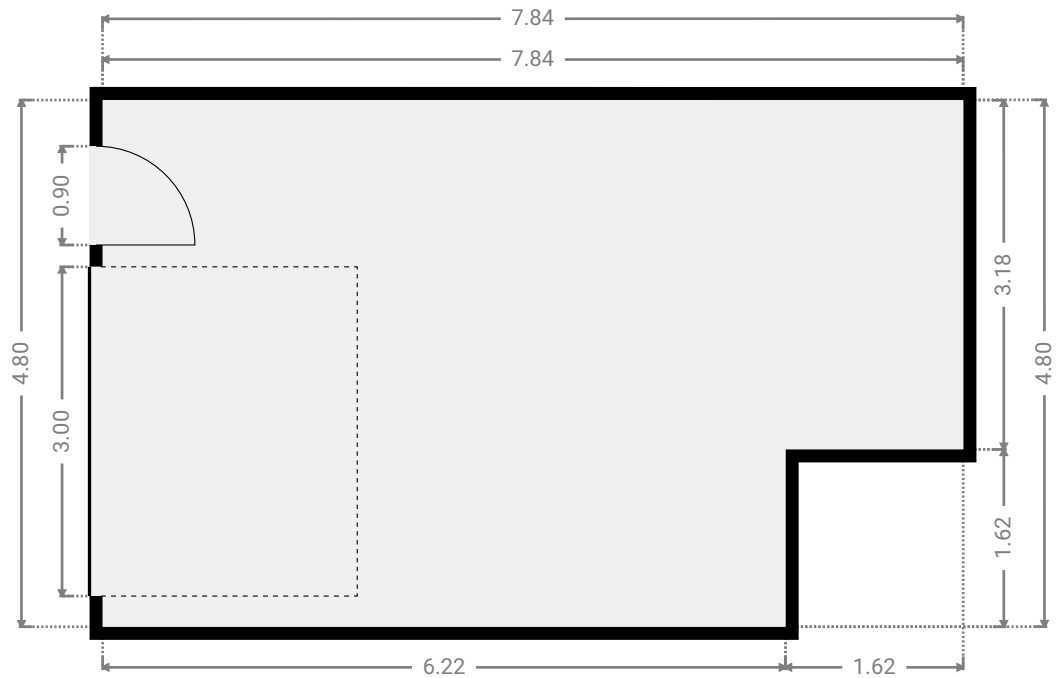
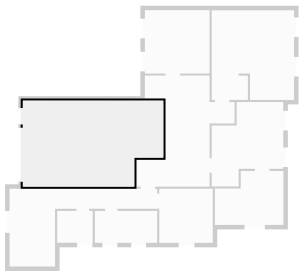

▼ **Heizungsraum**
1. Untergeschoss

BREITE: 2.98 m • LÄNGE: 3.02 m
BEREICH: 9.00 m² • UMFANG: 12.00 m

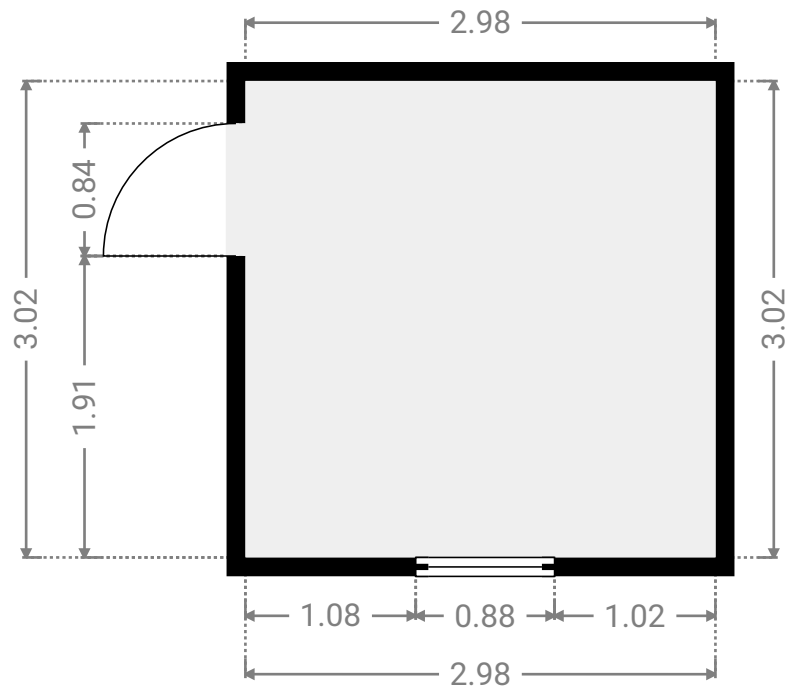
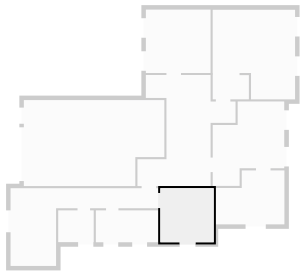

▼ **Keller**
1. Untergeschoss

BREITE: 3.61 m • LÄNGE: 3.54 m
BEREICH: 12.77 m² • UMFANG: 14.30 m

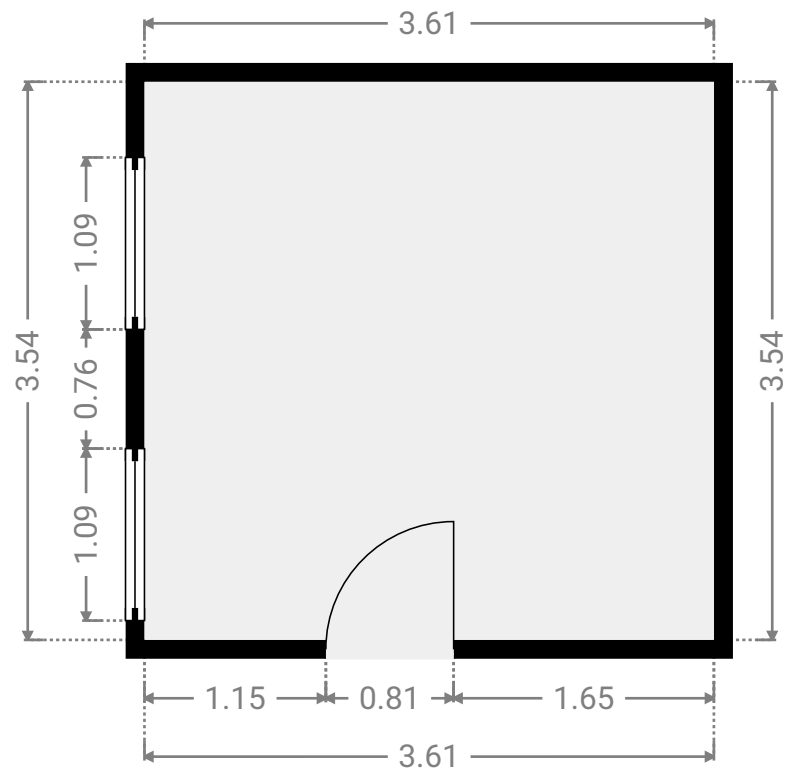
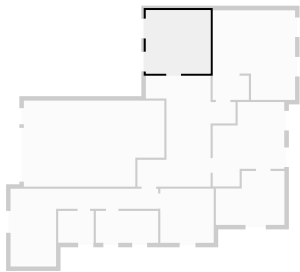

▼ **Küche**
1. Untergeschoss

BREITE: 3.83 m • LÄNGE: 3.01 m
BEREICH: 10.10 m² • UMFANG: 13.67 m

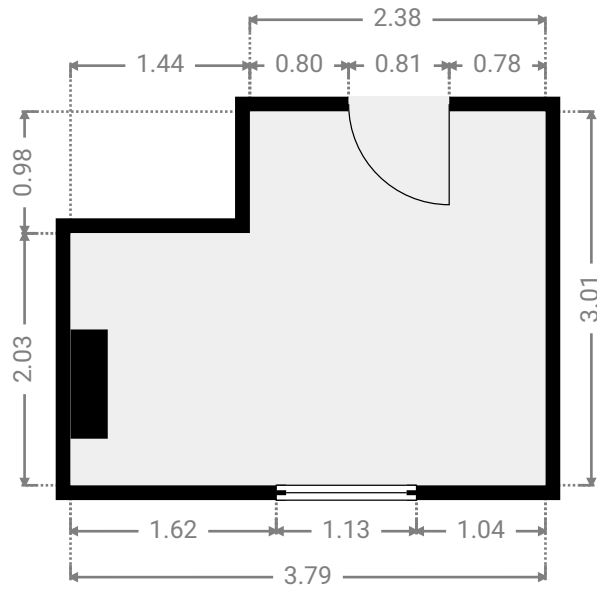
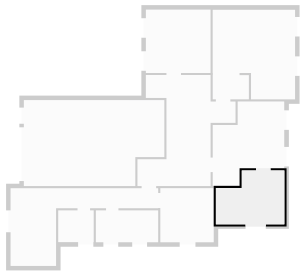

▼ **Sauna**
1. Untergeschoss

BREITE: 4.60 m • LÄNGE: 5.00 m
BEREICH: 19.85 m² • UMFANG: 19.20 m

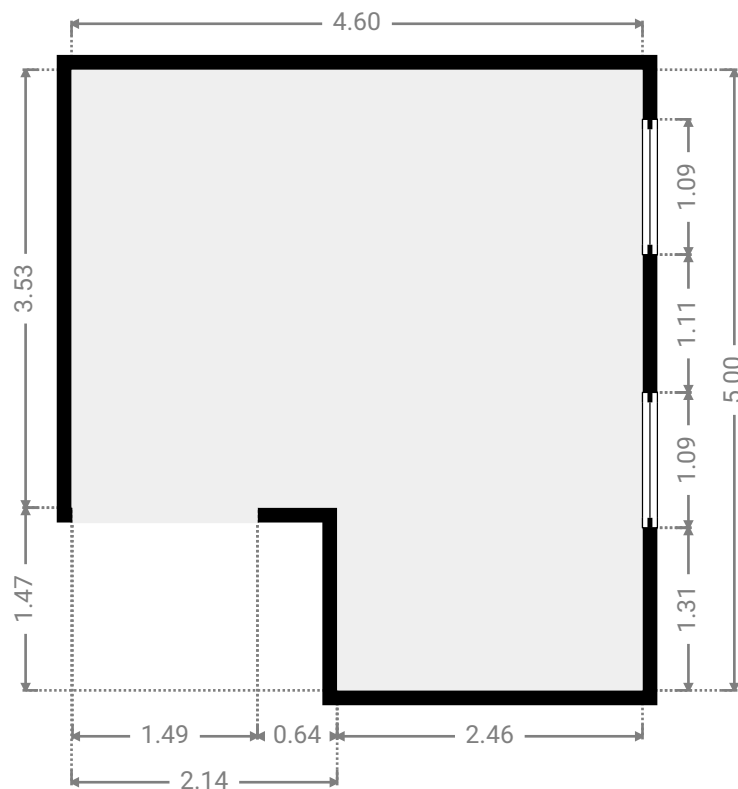
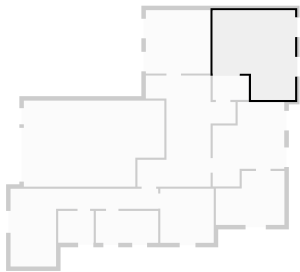

▼ **Schlafzimmer**
1. Untergeschoss

BREITE: 3.99 m • LÄNGE: 4.71 m
BEREICH: 14.52 m² • UMFANG: 17.41 m

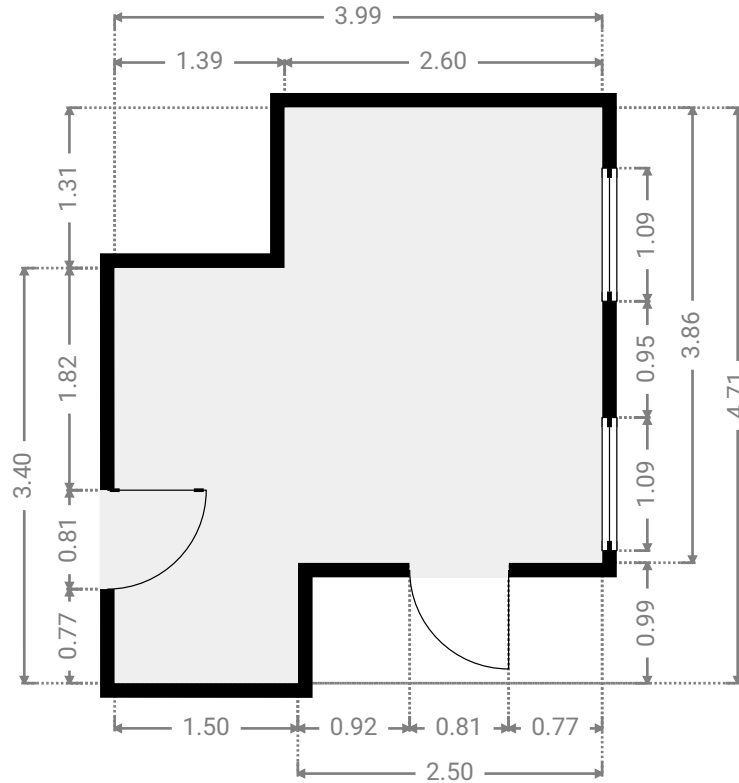
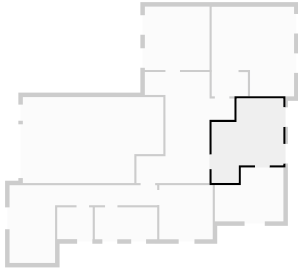

▼ **Treppenhaus**
1. Untergeschoss

BREITE: 2.54 m • LÄNGE: 3.10 m
BEREICH: 7.87 m² • UMFANG: 11.28 m

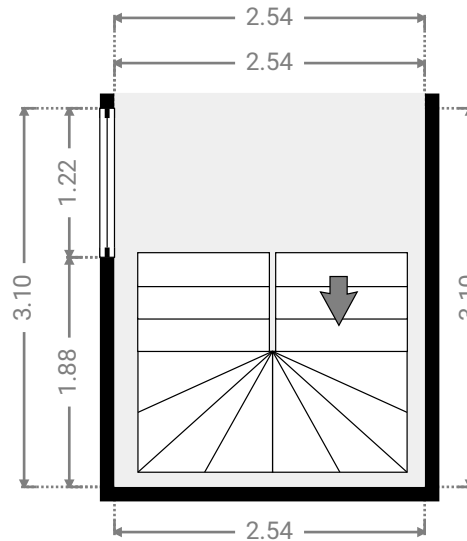
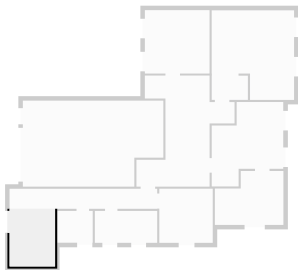

▼ WC
1. Untergeschoss

BREITE: 1.98 m • LÄNGE: 1.77 m
BEREICH: 3.51 m² • UMFANG: 7.50 m

